



GAZEBO penguin inc.

4660 HICKMORE ST,
MONTREAL, QUEBEC
H4T 1K2
TEL: 1-514-276-3485, 1-800-737-7174
Email: customerservice@gazebopenguin.com

**PLEASE READ
IN ITS ENTIRETY
BEFORE
INSTALLATION**

436586-22 GRILL GAZEBO INSTALLATION MANUAL

**PLEASE READ
IN ITS ENTIRETY
BEFORE
INSTALLATION**



**DO NOT DESTROY THE BOXES UNTIL COMPLETELY ASSEMBLED
FOR FUTURE REFERENCE,
TAKE PICTURES OF ALL SIX SIDES OF EACH OF THE BOXES UPON RECEIPT.
PLEASE VERIFY THE CONTENT OF EACH BOX AGAINST THE LIST OF PARTS**

Two or more adults required for assembly

Base Dimensions 6'10 1/2" x 4'11 1/4";
Largest Dimensions 7'10" x 4'11 1/4"
Overall Height 92" (7'8")

APPROX.

**DO NOT DESTROY THE BOXES UNTIL COMPLETELY ASSEMBLED
FOR FUTURE REFERENCE,
TAKE PICTURES OF ALL SIX SIDES OF EACH OF THE BOXES UPON RECEIPT.
PLEASE VERIFY THE CONTENT OF EACH BOX AGAINST THE LIST OF PARTS**

8ft x 5ft / 2.4m x 1.5m GRILL GAZEBO

Instruction Manual

IMPORTANT: RETAIN FOR FUTURE REFERENCE, READ CAREFULLY

Consult with your local governing authority / local municipal codes regarding installation of temporary structures before purchase or assembly. Some jurisdictions may require permits for, or otherwise regulate, installation and use.

For assistance with assembly, installation, parts, or customer service, contact Gazebo Penguin Customer Service Department at the numbers listed below (English & French, Mon-Fri 8:00 AM to 4:00 PM EST):

Montreal: (514) 276-3485

Elsewhere in Canada and the US: 1-800-737-7174

WARNING:

- For outdoor use.
- Snow should be regularly cleared from the roof and not allowed to accumulate.
- Retain your **proof of purchase** for warranty purposes. Also keep the **original boxes** until the installation is complete and correct.
- The unit may take more than 2 hours and 2 people are required for this assembly.



PRIOR TO ASSEMBLY:

- Please don't destroy boxes until completely assembled.
- The foundation must be level, flat, and solid, such as concrete or asphalt.
- Keep away from overhead utility lines, tree branches, and other structures.
- Check for underground pipes or wires if digging or drilling is required.
- Do not install near roof lines or other structures that could shed snow, ice, or excessive rain run-off onto the roof top.
- Assemble the structure as close to its final location as possible.
- It is recommended to wear safety gloves, safety glasses, and hard hats for installation.
- Do not hang from, climb on, or stand on the structure or roof.
- Before assembly, read instructions and check that all parts are present in the boxes. If any parts are missing, refer to warranty information.
- A 6ft (1.8m) stepladder, Phillips screwdriver, flat head screwdriver, tape measure, level, mallet, and a tarp to place parts on will be required for assembly (not included).
- Remove top protective film from roof panels prior to assembly; **DO NOT** remove bottom protective film until ready to insert roof panels, so as to identify which side is on top.

ANCHORING INSTRUCTIONS:

- Proper anchoring of the frame to the base and the wall is required for safety.
- Any structure not anchored securely has the potential to fly away during high wind causing damage and safety hazard.
- How the item is anchored, and the hardware and tools required, will vary based upon the set-up location and are not provided.
- Please check with your local hardware store if for the appropriate anchors for your surface.
- Do not anchor to pavers / pavement slabs because they are not a solid foundation.
- Periodically check the anchors to ensure they remain secure

CARE AND MAINTENANCE:

- In case of a defective or damaged part, or for any other questions concerning the product, please contact the manufacturer directly.
- Please have the parts list and part numbers on hand when ordering or requesting replacement parts.

ROOF PANELS:

- Gently clean with an environmentally-friendly soap solution and water using a sponge or washcloth.
- Do not use abrasive materials, wire brushes, chemicals, harsh cleaners, or bleach.
- Rinse using a garden hose and air dry. If removed, ensure thoroughly dry prior to storage.
- Do not use pressure washer.

STRUCTURE:

- Gently clean with an environmentally-friendly soap solution and water using a sponge or washcloth.
- Do not use abrasive materials, wire brushes, chemicals, harsh cleaners, or bleach.
- Rinse using a garden hose and air dry.
- Do not use pressure washer.
- If there are nicks, chips, and/or scratches see the part # of the paint in the parts list to obtain a matching touch-up paint.

MAINTENANCE NOTES

1. In case of a defective or damaged part, or for any other questions concerning the product, please contact the manufacturer directly.
2. Please have the parts list and part numbers on hand when ordering or requesting replacement parts.
3. The product should not be installed adjacent to trees or a sloped roof. Snow and ice may slide onto the roof and cause it to collapse.
4. While the product is designed to stay assembled year long, the roof must be kept free of accumulation of snow.



ONE YEAR LIMITED WARRANTY

This product has been designed and manufactured to meet the highest standards of quality and durability. Subject to the Conditions for Exercising the Warranty and the Limitations on the Warranty set forth below, it is warranted to be free of material and manufacturing defects for a period of **one year** from the date of purchase. Missing and damage due to transportation is not covered by the manufacture warranty. Should the product become damaged, or the warranty period has expired, please contact Gazebo Penguin Customer Service Department for a complete schedule of replacement parts and prices.

CONDITIONS FOR EXERCISING THE WARRANTY

The warranty only applies to the original purchaser with the bill.

In order to properly exercise your warranty, please comply with the following:

Carefully inspect the contents of the carton for missing or damaged components. Should you discover damaged or missing parts, **do not return the product to the place of purchase**, but contact Gazebo Penguin Customer Service Department at the numbers listed below:

Montreal: (514) 276-3485

Elsewhere: 1-800-737-7174

You can also find a claim form to fill out online:

<http://www.abrispenguin.com/forms.html>

NOTE: Damages/missing parts must be reported within 30 days of delivery. If claimed after your request might be rejected.

LIMITATIONS ON THE WARRANTY

1. The product is not warranted against damages due to vandalism, abuse, falling or thrown objects, or accumulation of snow.
2. The product is not warranted against damages due to extreme weather conditions, such as thunderstorms, hail, strong wind or snow storms, or any other acts of God.
3. Leaking due to heavy rain may happen, please refer to the instruction manual for window positions and information on how to evacuate the water.
4. The product is only warranted in the event it is installed in accordance with the Gazebo Penguin's written instructions enclosed with the product.
5. The product is not warranted in the event it has been improperly anchored.
6. We reserve the right to replace or repair any defective product or parts at our discretion.
7. No change to the unit is allowed. This will void your warranty.

Before Assembly:

PLEASE DON'T DESTROY BOXES UNTIL COMPLETELY ASSEMBLED.

- Please verify the content of each box against the list of parts.
- For future reference, take pictures of all six sides of each of the boxes upon receipt.
- Read instructions and check that all parts are present in the boxes.
If any parts are missing, refer to warranty information on pg. 10.
- Assembly will require at least two persons and 2 hours.
- A stepladder will be required for assembly.
- The gazebo should be assembled on a level, flat surface.

Step 1:—

Assemble each Leg (A, B, C, D) onto Base (E) using Bolt (U), Washer (U-2), and Acorn Nut (U-1). Each base can be installed in 4 directions, orient as required for your surface.

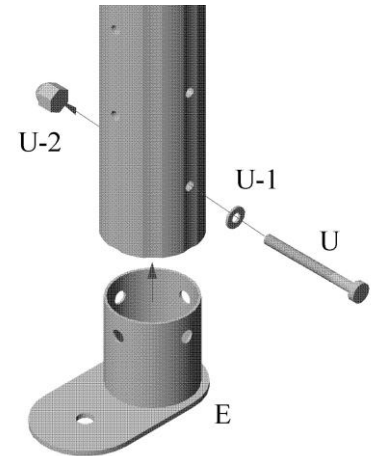

Step 2:

Assemble Shelf Support Bar (F-1) under each Top Shelf (F) using 4 Bolts (Bb) and Locknuts (Aa-1) each. Attach one shelf between Legs (A & C) using 4 Bolts (Y). Repeat with the second Top Shelf between Legs (B & D).

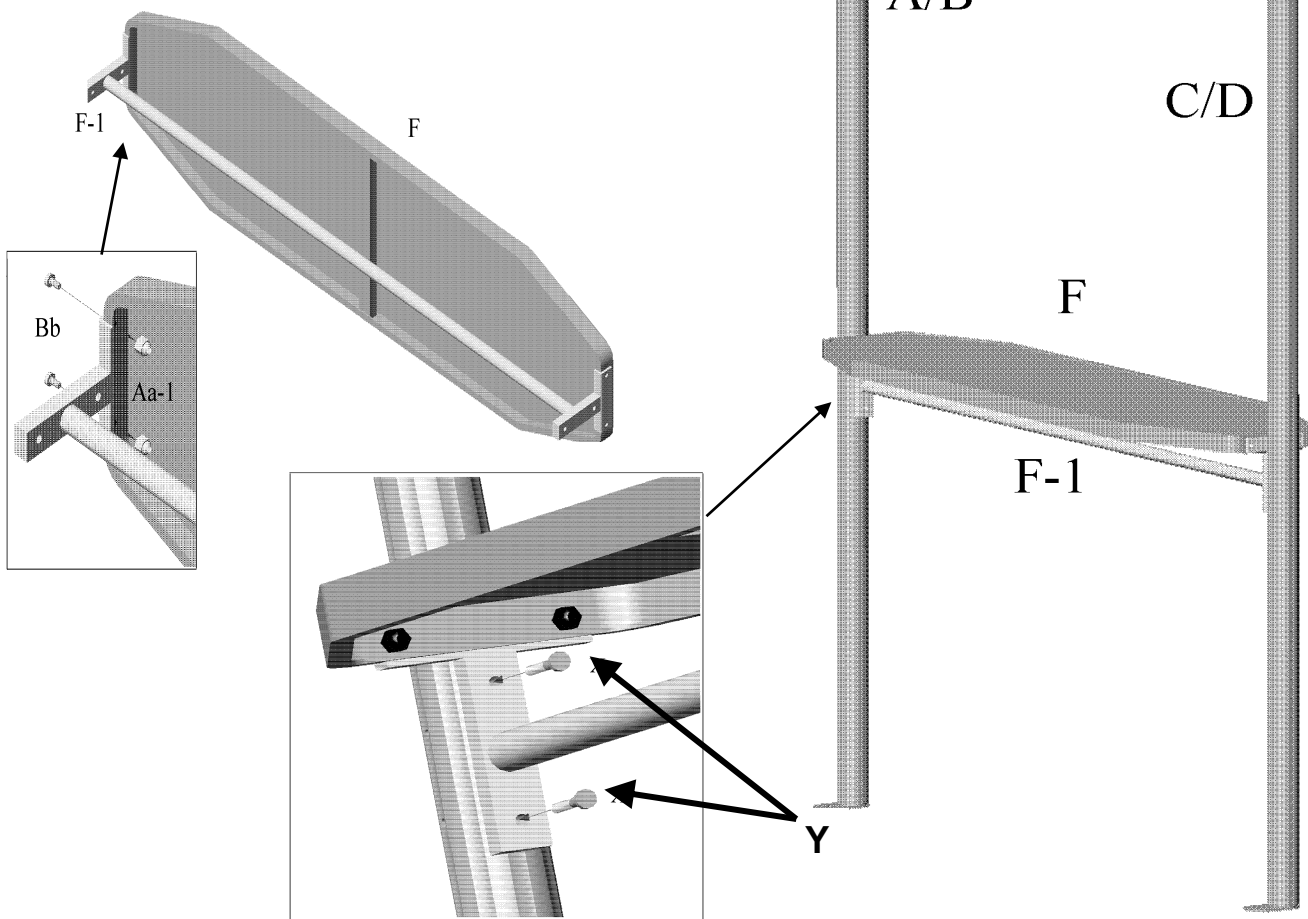

Step 3:

Attach the rear bars (G) between legs (A & B) using 2 bolts (Z1) at each end. Then install the central bar (G-1) at the center of the two rear bars, using bolts (V).

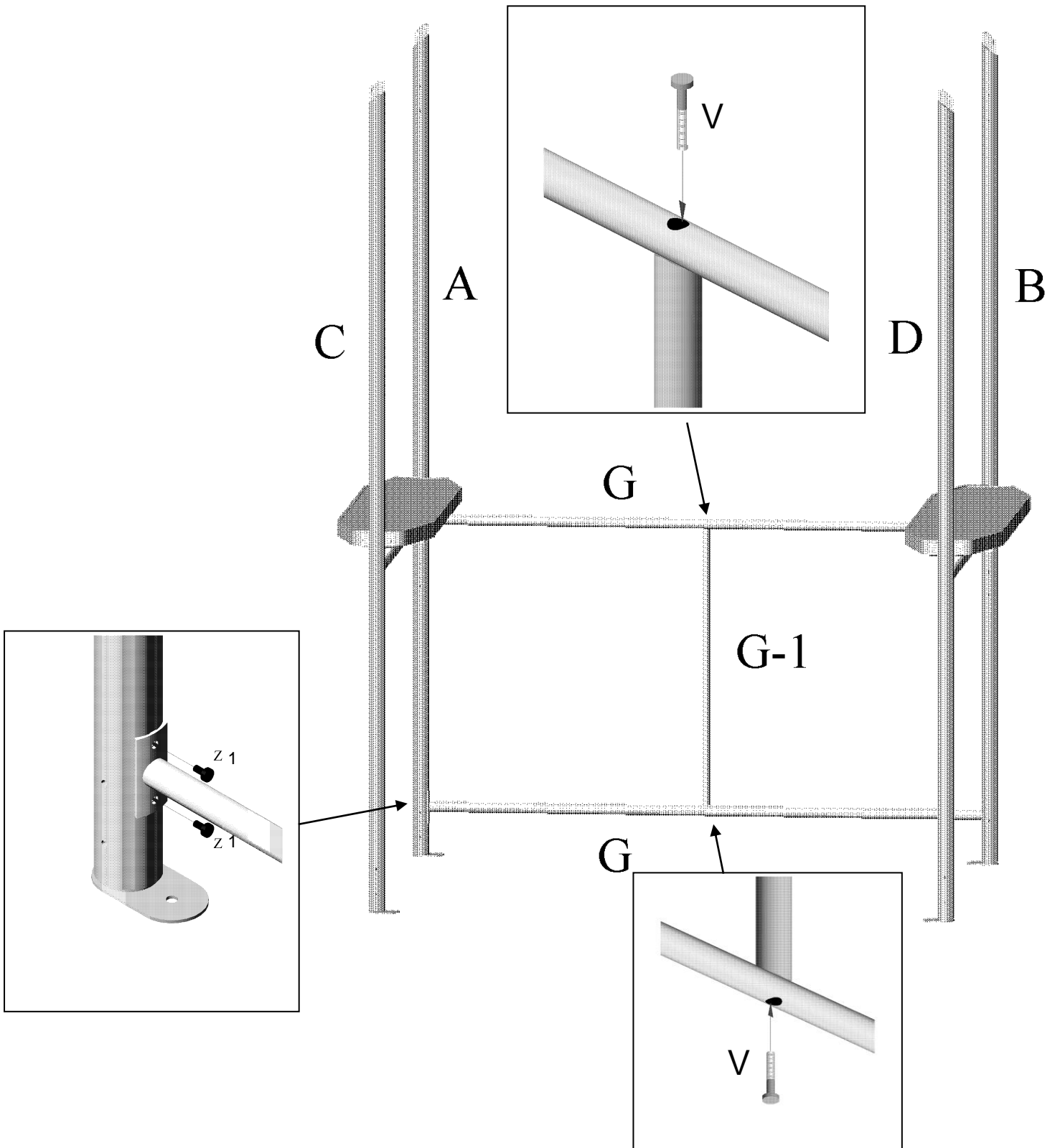

Step 4:

Attach the bottom side bars (H) at the bottom between legs (A & C) and (B & D) using bolts (U). Attach the top side bars (I) at the top between legs (A & C) and (B & D) using bolts (Z1). Attach the top bars (J) between legs (A & B) and (C & D), again using bolts (Z1).

Note: The hole on top bar (J) is not exactly at the Center, so during assembly ensure that the holes on both top bars (J) are equally spaced from the same top side bar (I).

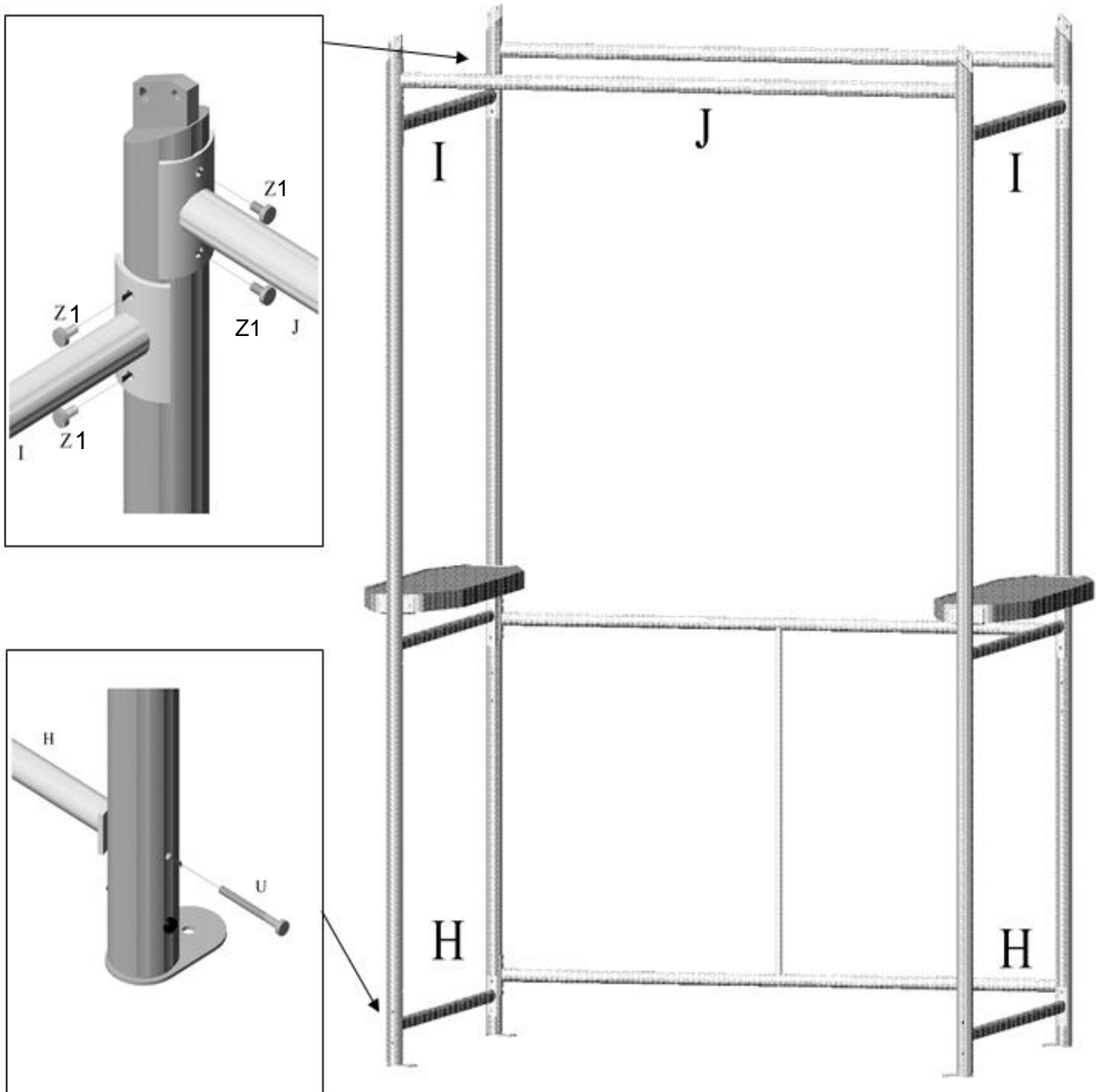

Step 5:

Screw cloth holder brackets (L-1 & L-2) to the cloth holder (L) using bolts (Z1). Then attach them between the right legs (B & D), also using bolts (Z1).

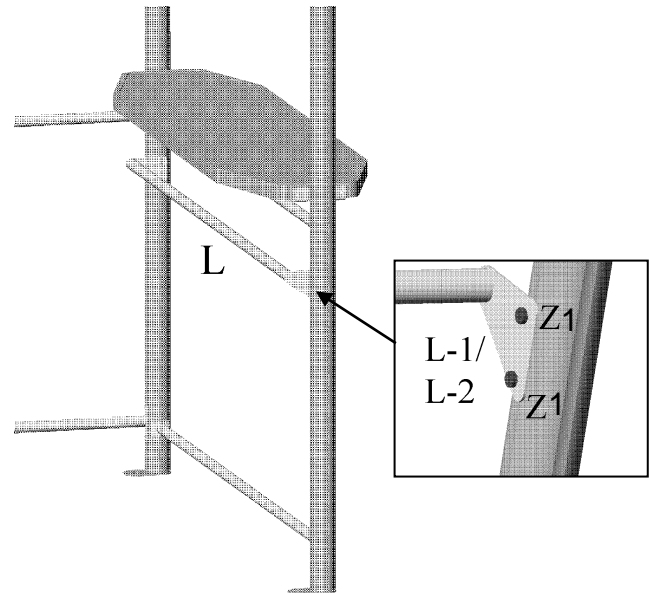

Step 6:

For the upper roof, lay out edge rafters (M & M-1), two edgings (O), roof panels (P), and rafters (Q), as shown in diagram. Attach rafter (M-1) and one edging (O) in one corner using a roof connector (R) and 4 bolts (Cc). Do the same with rafter (M). Prepare the other Edging (O) with Corner Connector (R) for the next step.

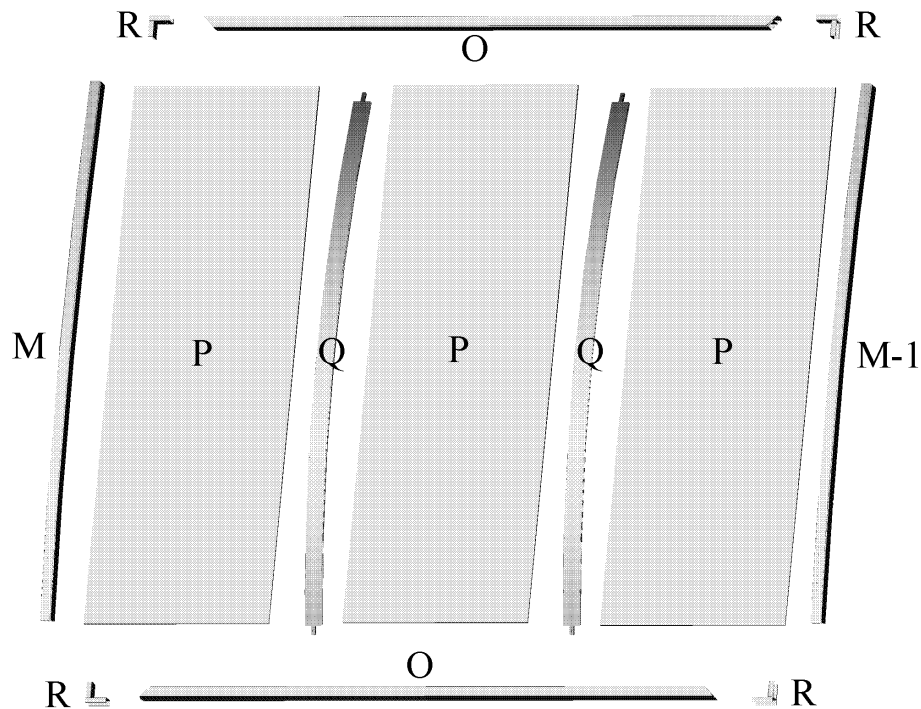

Step 7:

Bend and slide Roof Panel (P) into one corner, then insert Rafter (Q) next to it, attaching the ends to the Edging (O) with Bolts (Cc). Add the next Roof Panel (P), then another Rafter (Q) in the same manner.

Insert the final Roof Panel (P), and then close the upper roof with the previously assembled corner (M & O), using Roof Connectors (R) at the corners and Bolts (Cc).

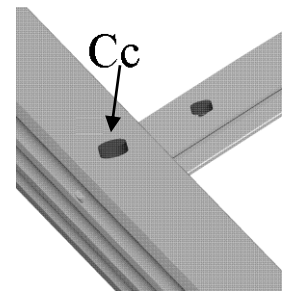
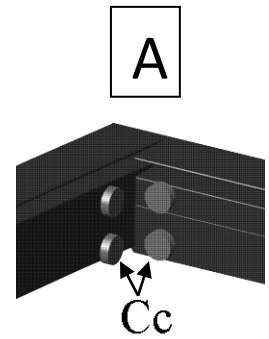
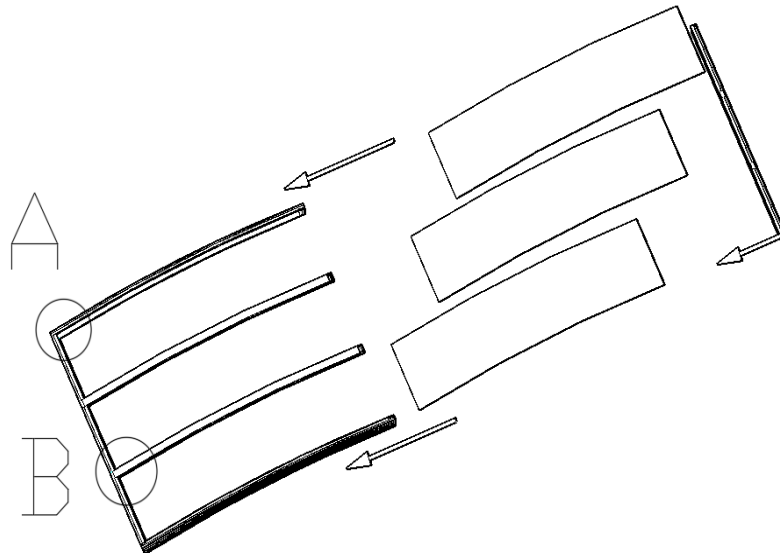

Step 8:

For the lower roof, lay out edge Rafters (N & N-1), two Edgings (O), Roof Panels (P-1), Roof Connectors (R) and Rafters (Q-1), as shown in diagram. Then repeat steps 6 and 7 using these pieces to complete the lower roof.

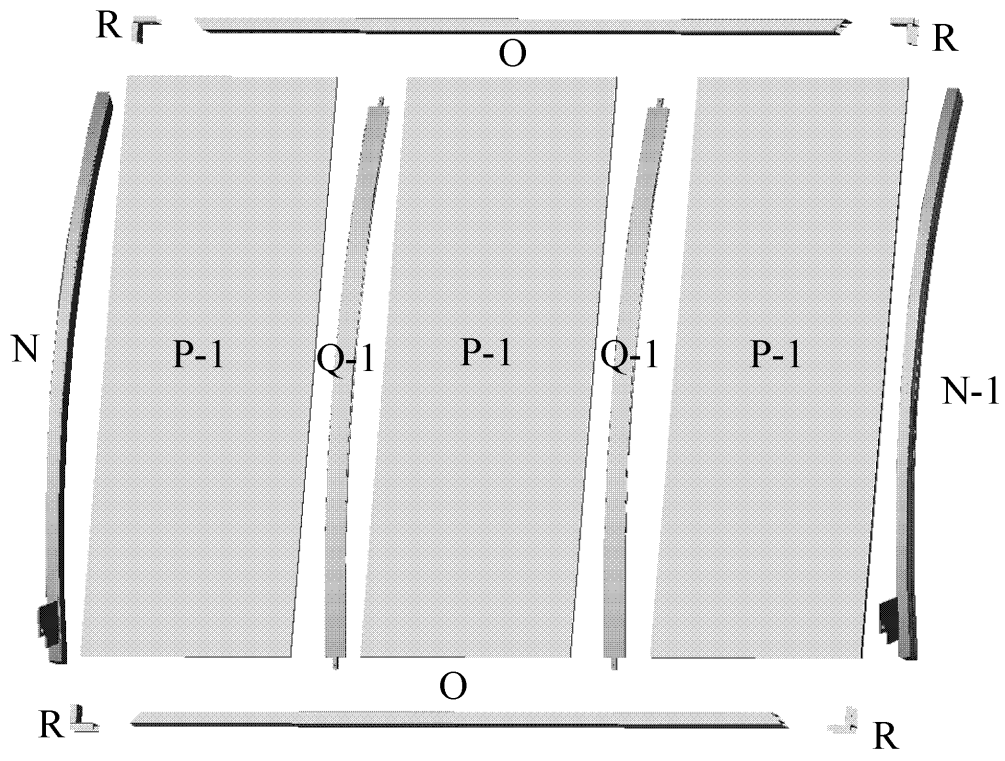

Step 9:

Attach roof supports (S) to the center of each top bar (J) using one bolt (V) each.

Attach the lower roof assembly to the roof supports (S) using bolts (Y), and to the top of legs (B & D) using 2 bolts (Z) per leg.



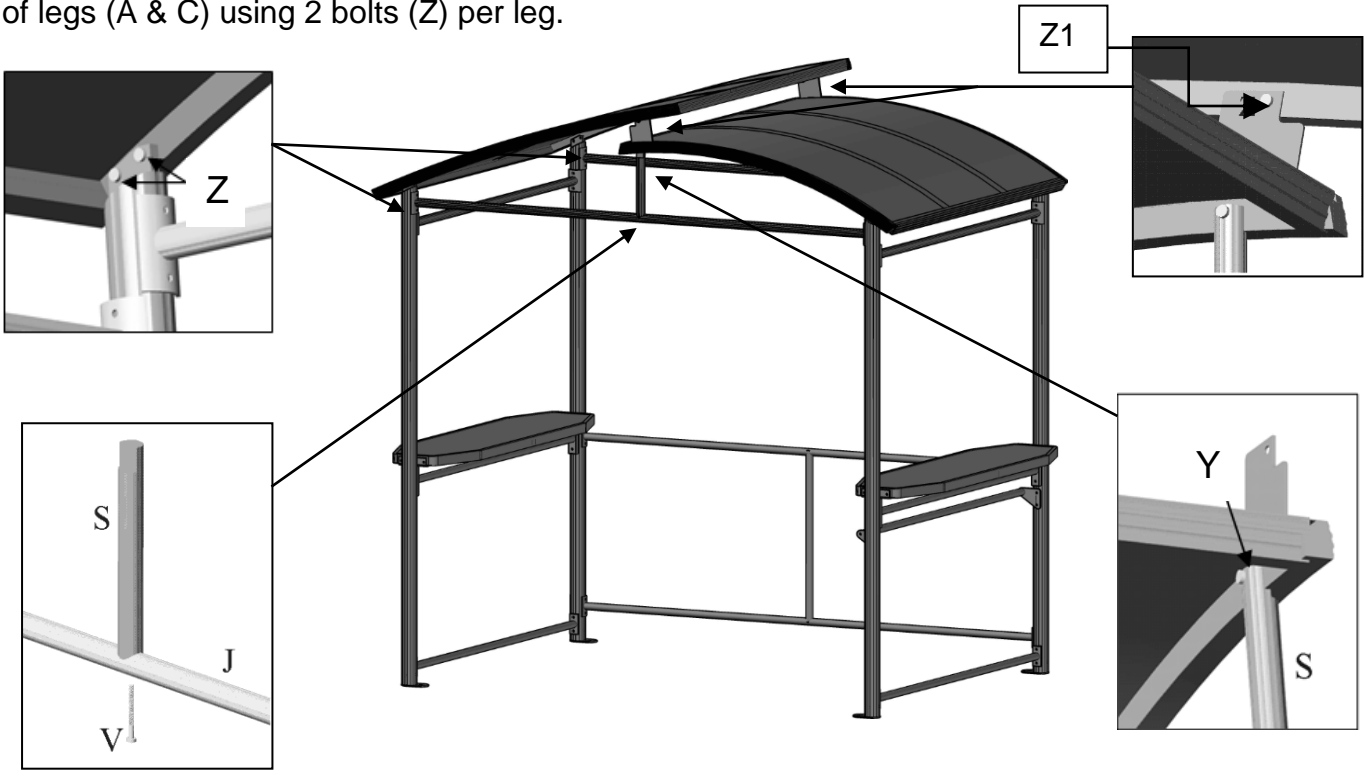





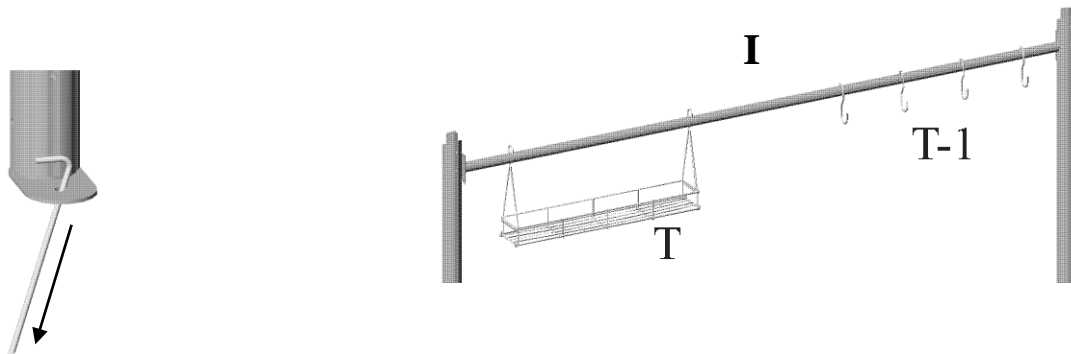

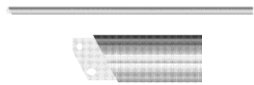







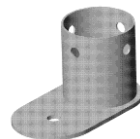

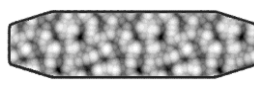
Attach the upper roof assembly to the plate on lower rafters (N & N-1) using bolts (Z1), and to the top of legs (A & C) using 2 bolts (Z) per leg.





















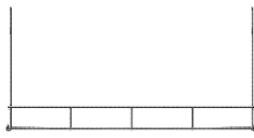

Step 10:

Anchor the unit to the ground through the bases (E). Use the provided nails (Dd), screws, and/or plugs as appropriate for your surface. If using nails, be sure to drive them in at an angle. Hang rack (T) and hooks (T-1) from the top side bar (I) as preferred.



| DESCRIPTION | PACKED IN BOX | QTY | DRAWING | DESCRIPTION | PACKED IN BOX | QTY | DRAWING |
|--------------------------------------------|---------------|-----|-------------------------------------------------------------------------------------|-----------------------------------------------|---------------|-----|---------------------------------------------------------------------------------------|
| (12-051) BACK LEFT LEG A | 2 | 1 |  | (12-061) TOP SIDE BAR I | 2 | 2 |  |
| (12-052) BACK RIGHT LEG B | 2 | 1 |  | (14-064) TOP BAR J | 2 | 2 |  |
| (12-053) FRONT LEFT LEG C | 2 | 1 |  | (12-065) CLOTH HOLDER L | 2 | 1 |  |
| (12-054) FRONT RIGHT LEG D | 2 | 1 |  | (12-066) CLOTH HOLDER BRACKET L-1 | 2 | 1 |  |
| (12-055) BASE E | 2 | 4 |  | (12-067) CLOTH HOLDER BRACKET L-2 | 2 | 1 |  |
| (12-056) TOP SHELF F | 3 | 2 |  | (12-068) UPPER EDGE RAFTER M | 2 | 1 |  |
| (12-057) SHELF SUPPORT BAR F-1 | 2 | 2 |  | (12-069) UPPER EDGE RAFTER M-1 | 2 | 1 |  |
| (12-058) REAR BAR G | 2 | 2 |  | (12-070) LOWER EDGE RAFTER N | 2 | 1 |  |
| (12-059) CENTRAL BAR G-1 | 2 | 1 |  | (12-071) LOWER EDGE RAFTER N-1 | 2 | 1 |  |
| (12-060) BOTTOM SIDE BAR H | 2 | 2 |  | (12-072) EDGING O | 2 | 4 |  |

| DESCRIPTION | PACKED IN BOX | QTY | DRAWING | DESCRIPTION | PACKED IN BOX | QTY | DRAWING |
|----------------------------------------------------------|---------------|-----|------------------------------------------------------------------------------------------------|-----------------------------|---------------|-----|--------------------------------------------------------------------------------------------------|
| (12-073) 54 3/4" x 19" UPPER ROOF PANEL P | 1 | 3 |  | (12-081) BOLT V | 2 | 4 |  M6x50mm |
| (12-074) 48" x 19" LOWER ROOF PANEL P-1 | 1 | 3 |  | (12-084) BOLT Y | 2 | 10 |  M6x30mm |
| (12-075) UPPER RAFTER Q | 2 | 2 |  | (12-085) BOLT Z | 2 | 8 |  M6x20mm |
| (12-076) LOWER RAFTER Q-1 | 2 | 2 |  | (15-118) BOLT Z1 | 2 | 36 |  M6x16mm |
| (12-077) ROOF CONNECTOR R | 2 | 8 |  | (12-086) LOCKNUT Aa-1 | 2 | 8 |  |
| (12-078) ROOF SUPPORT BAR S | 2 | 2 |  | (08-168) BOLT Bb | 2 | 8 |  M6x12mm |
| (12-079) RACK T | 2 | 1 |  | (12-087) BOLT Cc | 2 | 40 |  M5x8mm |
| (12-080) HOOK T-1 | 2 | 4 |  | (12-088) NAIL Dd | 2 | 4 |  |
| (08-161) BOLT U | 2 | 8 |  M6x70mm | (08-181) ALLEN KEY | 2 | 1 |  |

| DESCRIPTION | PACKED IN BOX | QTY | DRAWING | DESCRIPTION | PACKED IN BOX | QTY | DRAWING |
|---------------------------------|---------------|-----|-----------------------------------------------------------------------------------|---------------------------------|---------------|---------------|---------|
| (12-089) ACORN NUT U-1 | 2 | 4 |  | *NOT INCLUDED IN THE BOX | | | |
| (08-187) WASHER U-2 | 2 | 4 |  | DESCRIPTION | COLOUR | PART # | |
| | | | | SPRAY PAINT | BROWN | 11-726 | |
| | | | | PAINT PEN | | 18-184 | |

NOTE: The Dimensions Are Approximate.

